

Fast Electrically Tunable Lens EL-3-10

The compact EL-3-10 lens was designed for OEM integration into optical systems for various applications. The working principle is based on the well-established shape-changing lens technology. The curvature of the lens is adjusted by applying an electrical current. Thereby, the focal length is tuned to a desired value within very few milliseconds. The lens architecture is “push pull” which means that the lens curvature is deflected from concave to convex. With actuators based on proven voice-coil technology, the EL-3-10 focus tunable lens is extremely reliable and robust, well suited even for applications in harsh environments over large temperature ranges.

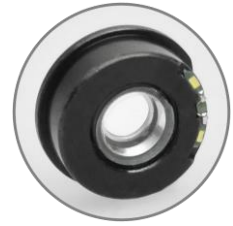

Option	EL-3-10-VIS	EL-3-10-NIR
Cover glass coatings	VIS ¹	NIR ²

Mechanical specifications

Clear aperture	3.0	mm	
Outer diameter	10	mm	11mm on flange
Height	4 +0/-0.2	mm	
Weight	1.25	g	
Lifecycles (10-90% sinusoidal)	>1'000'000'000	CL	

Electrical specifications

Control current (typical)	-120 to +120	mA	
Operating voltage	-1...1	V	
Coil resistance at 30°C	7.1	Ohm	
Power consumption (full tuning range)	0 to 100	mW	$P = R_{Coil} \times i^2$
Power consumption (+/- 5 dpt tuning range)	0 to 15	mW	
Settling time	2/4	ms	Low pass filtered / normal step signal

Optical specifications

	EL-3-10-XXX-26D		
Focal tuning range (@20°C)	-77 to +77	mm	
Focal power range (@20°C) ³	-13 to +13	dpt	
Wavelength range	420 to 1600	nm	
Wavefront error @525nm (vertical/horizontal)	<0.2/<0.2	λRMS	Tighter spec available upon request (e.g. 0.07 λRMS)
Refractive index n_D (589.3nm)	1.300		
Abbe number V_d	100		
Optical damage threshold	>1	kW/cm ²	
Operating temperature	-20 to +65	°C	
Storage temperature	-50 to +85	°C	

Overview of standard products

Standard products	Tuning range ³	Flex cable	Cover glass	Container- and/or cover glass coating	Wavefront error ⁴
EL-3-10-VIS-26D-FPC	-13 to +13 dpt	Yes	Yes	420 – 900 nm	<0.2/<0.2 λ
EL-3-10-NIR-26D-FPC	-13 to +13 dpt	Yes	Yes	850 – 1600 nm	<0.2/<0.2 λ
EL-3-10-VIS-26D-OEM	-13 to +13 dpt	No	No	420 – 900 nm	<0.2/<0.2 λ
EL-3-10-NIR-26D-OEM	-13 to +13 dpt	No	No	850 – 1600 nm	<0.2/<0.2 λ
EL-3-10-VIS-26D-OEM-CG	-13 to +13 dpt	No	Yes	420 – 900 nm	<0.2/<0.2 λ

¹ 420-900 nm T>94%

² 850-1600 nm T>94%

³ Optical power ranges of up to +/- 35 dpt are available on request

⁴ Wavefront error in λRMS @525 nm across the whole optical power range with optical axis vertical / horizontal

Mechanical drawings

The standard EL-3-10 lens has a flex cable (Figure 2), compatible with our EL-E-4 lens driver, designed for prototyping and low volume applications. In addition, an OEM version of the EL-3-10 lens for high volume applications is available. It has two soldering pads that can be used to solder cables to or to connect with spring contacts (Figure 1). The full field of view towards the top is 50°. The full field of view towards the bottom is specified with 46°. For the OEM version, the protective cover glass is optional, allowing to optimize transmission.

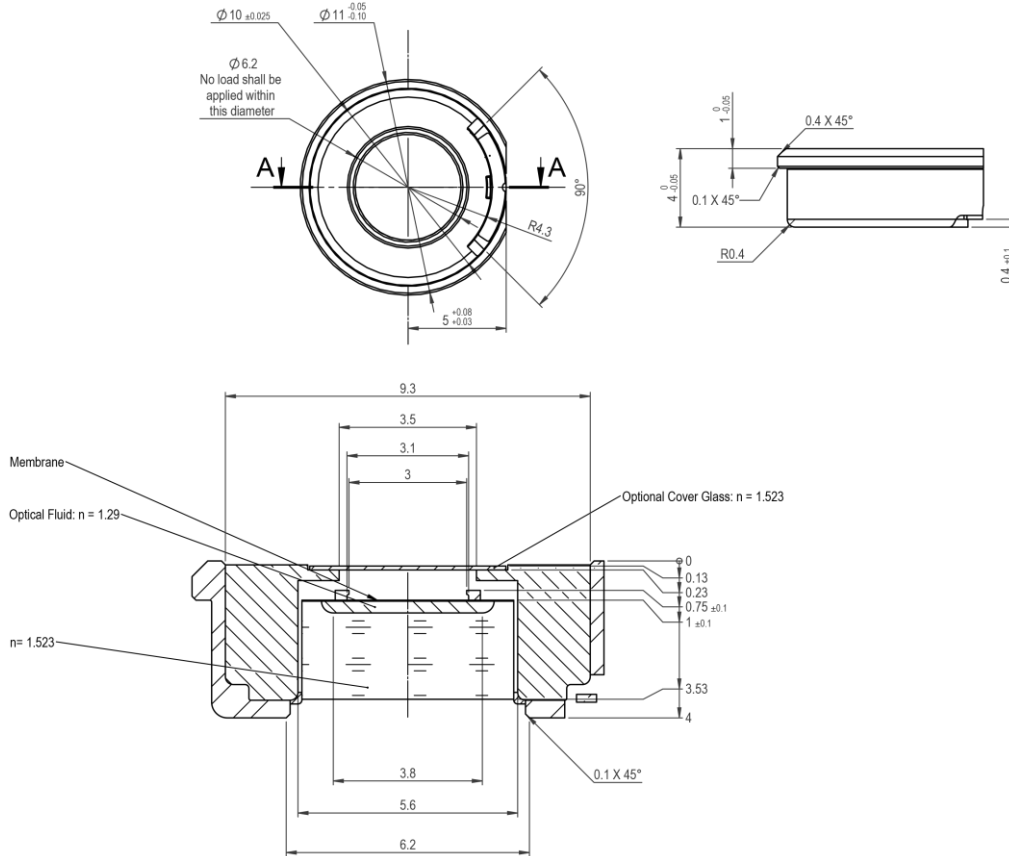

Figure 1: Mechanical drawing of the EL-3-10-XXX-26D-OEM lens

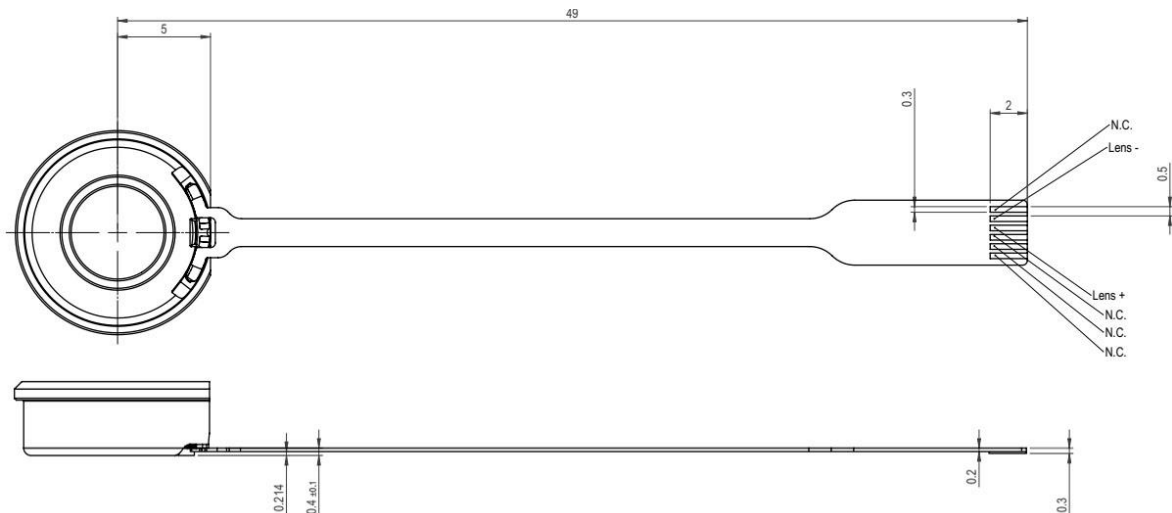

Figure 2: Mechanical drawing of the EL-3-10-XXX-26D-FPC lens

Mounting

To mount the lens, it is clamped on the flange. The orientation is defined by the D-cut. For version with no cover glass, on the bottom aperture, the membrane is exposed to the environment. Therefore the lens needs to be integrated in a clean environment (e.g. clean room) and designed into an optical system so that the bottom interface is protected against dust.

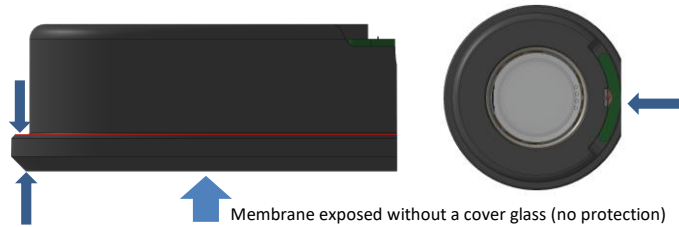

Figure 3: EL-3-10 mounting

Electrical connection

For the OEM version, on the two PCB solder pads, wires can be connected. Alternatively, spring loaded pins can be used for the contact on the PCB solder pads (for example TE 1551631-5).



Figure 4: Soldering pads with spring loaded pins for EL-3-10-XXX-26D-OEM

The standard FPC version has a flex cable soldered to the soldering pads described above and compatible with Optotune's lens driver 4, as shown in Figure 5.



Figure 5: EL-3-10-XXX-26D-FPC with flex cable

Driver

The compact EL-3-10 lens can be driven with Optotune's EL-E-4 lens driver by simply connecting the flex cable of the lens to the Molex connector on the lens driver. In Optotune's software interface, the current to the lens can be adjusted to drive the lens. It's important to note that ± 120 mA are required to tune across the whole optical power range. As the lens driver can output more current, it has to be connected to the PC without the lens connected first. Then, in the "Hardware Configurations" tab, the software limit has to be set to ± 120 mA. Afterwards the lens driver can be disconnected, the lens connected to the lens driver and the lens driver connected back to the PC. The current will now only be adjustable from ± 120 mA, hence an overdriving of the lens can be prevented.

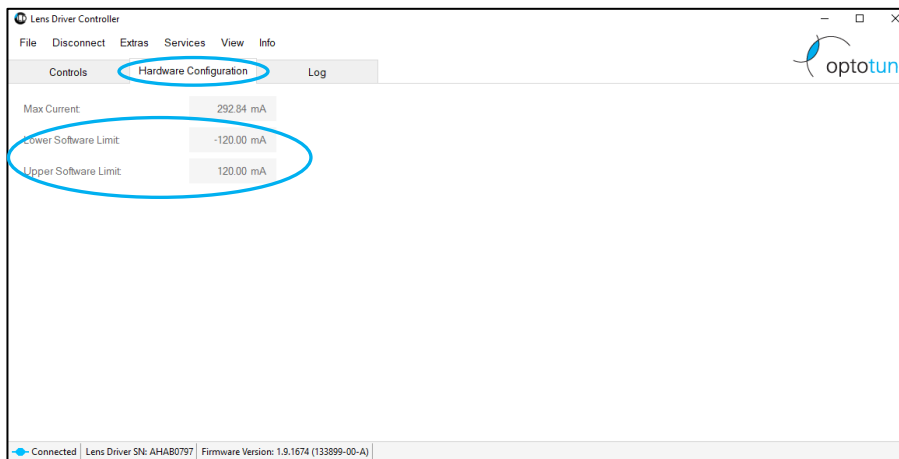

Instructions

1. Connect lens driver to the PC without a lens connected
2. Open the lens driver controller software
3. Go to the hardware configurations tab
4. Set the lower software limit to -120mA
5. Set the upper software limit to 120mA
6. Close the software window
7. Disconnect the lens driver
8. Connect the lens to the lens driver
9. Connect the lens driver to the PC
10. Open the lens driver controller software
11. Use the slider to adjust the current to the lens

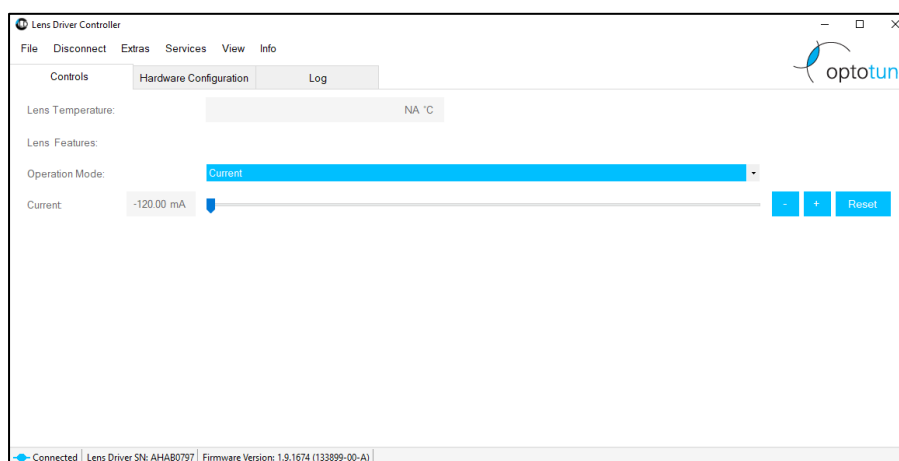

Working principle

The working principle of the EL-3-10 is based on Optotune's well-established technology of shape-changing polymer lenses. The core that forms the lens contains an optical fluid, which is sealed off with an elastic polymer membrane as shown in Figure 6. An electromagnetic actuator is used to exert pressure on the container and therefore changes the curvature of the lens. By changing the electrical current flowing through the coil of the actuator, the optical power of the lens is controlled.

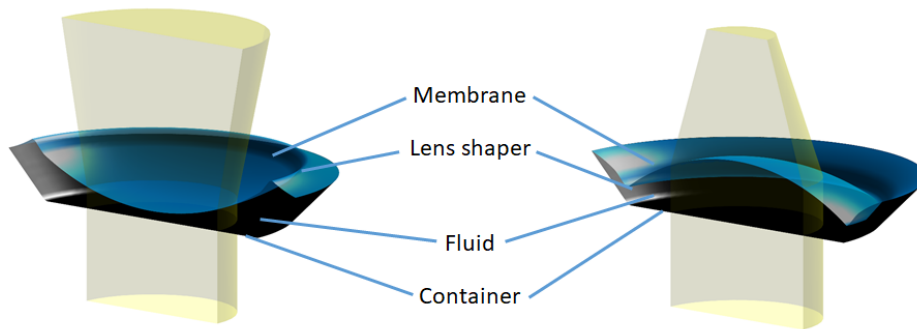

Figure 6: Scheme of the sealed lens container filled with an optical fluid and embedded in an EL-3-10 housing

Optical power versus current

The optical power of the EL-3-10 increases with positive current and decreases with negative current as shown in Figure 7. The specified optical power range is from +13 to -13 diopters

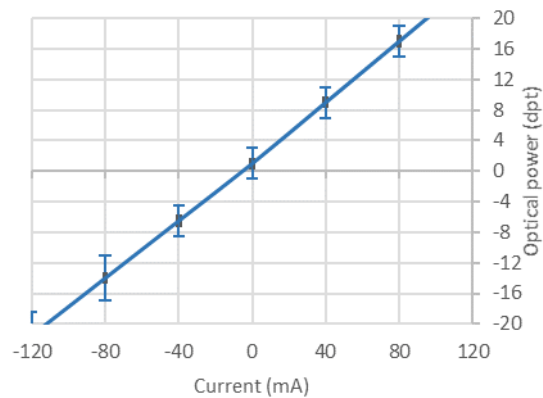

Figure 7: EL-3-10 current vs optical power graph

Transmission range

Both the optical fluid and the membrane material are highly transparent in the range of 400 to 2500 nm. As the membrane is elastic it cannot be coated using standard processes, hence a reflection of 3 – 4% is to be expected. Cover glasses can be coated as desired. Figure 8 shows the transmission spectrum for the standard VIS and NIR broad-band coating.

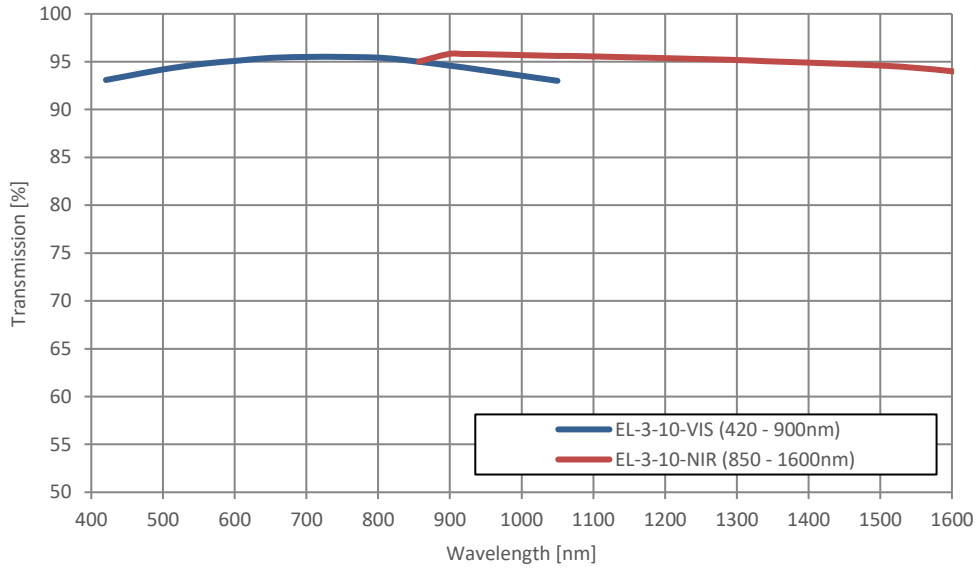

Figure 8: Transmission spectra of EL-3-10 standard VIS and NIR coating

Optical quality

In principle, Optotune's focus tunable lenses exhibit a spherical lens shape (the nominal parameters can be found in the ZEMAX package, which is available for download on www.optotune.com).

Optotune's focus tunable lenses are typically subject to gravity induced coma aberrations when used in the horizontal optical axis. Due to the small clear aperture and stiff membrane of the EL-3-10 lens, there is no measurable Y-coma in the horizontal optical axis. However, the focal power of the EL-3-10 lens is slightly affected by acceleration. 1g results in about 0.15dpt change in focal power.

A typical wave front error across the whole focal power range can be seen in Figure 9 below.

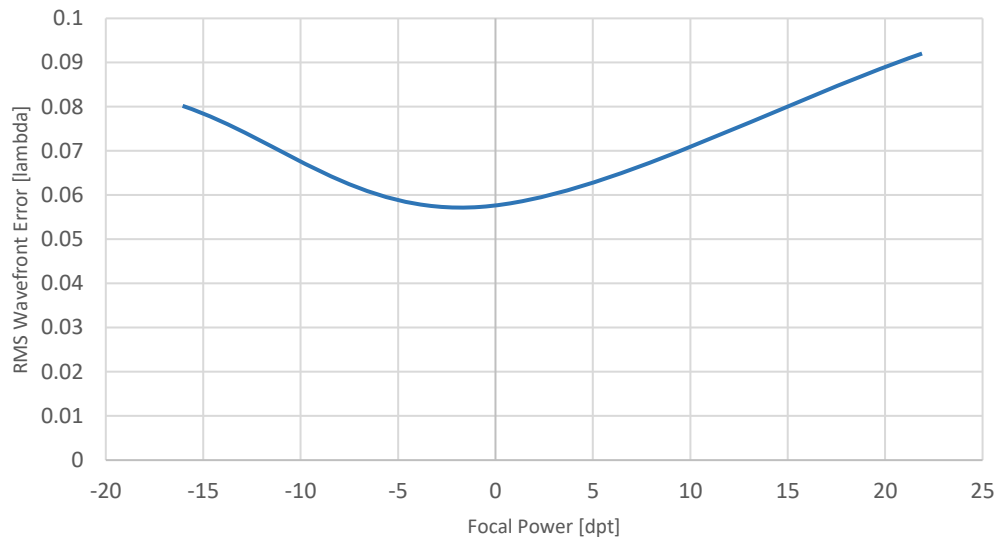

Figure 9: Typical RMS wave front error of the EL-3-10

Response time

The rise time when applying a current step is <1 ms and it takes only about 4 ms until the lens has fully settled. The graphs of the step response measurements below show the optical response of the EL-3-10 lens. Low pass filtering of the drive signal to the lens allows to damp the oscillations seen in the step response graphs below and as a result drive a controlled 80% step in <2ms.

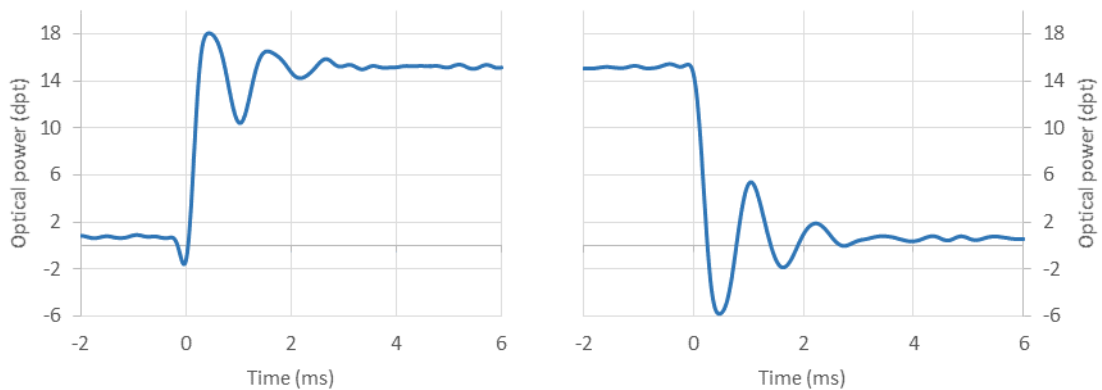

Figure 10: 80% step response of the EL-3-10 lens

Temperature effects

Residual temperature effects influence the long term drift of optical power. These temperature effects are quantified by the temperature sensitivity, giving the change in optical power per degree Celsius. Depending on the optical power, the temperature sensitivity of the EL-3-10 increases or decreases according to the graph in Figure 11. For repeatable optical power driving across the whole temperature and optical power range, additional active temperature compensation is necessary. As illustrated in Figure 11, the temperature sensitivity decreases with increasing optical power. Hence, it is recommended to work in the positive optical power range, where temperature sensitivity is lowest.

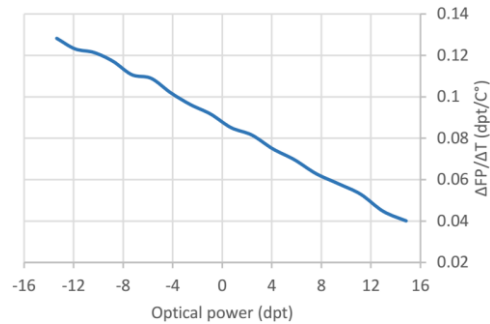

Figure 11: EL-3-10 temperature sensitivity across the optical power range

Optical layout

Zemax simulations to model the EL-3-10 lens within an optical design are available upon request.

Safety and compliance

The product fulfills the RoHS and REACH compliance standards. The customer is solely responsible to comply with all relevant safety regulations for integration and operation.

For more information on optical, mechanical and electrical parameters, please contact sales@optotune.com.