



shaping the future of optics



12 mm lens with integrated EL-16-40

Test report of Optotune ELM-12-2.8-18-C (a.k.a. VS-FT12HV)

December 2019

Jennifer Studer, Sarah Kurmulis & Mark Ventura

Optotune Switzerland AG | Bernstrasse 388 | CH-8953 Dietikon | Switzerland
Phone +41 58 856 3011 | www.optotune.com | info@optotune.com

Summary of Optotune ELM-12-2.8-18-C

High resolution and **large field of view (FOV)** at the same time

- Ideal for code reading and OCR applications, e.g. in logistics

Working distance (WD) range from 250mm to infinity

- Best MTFs in the range of 500 to 1000mm
- High optical leverage (1.13 m/dpt)

Resolution for 2.4um pixels (e.g. Sony IMX253/304 1.1" or IMX183 1")

- Image center at Nyquist limit (up to 208 lp/mm)
- Image corners between 90-168 lp/mm
- Best resolution at F/5.6

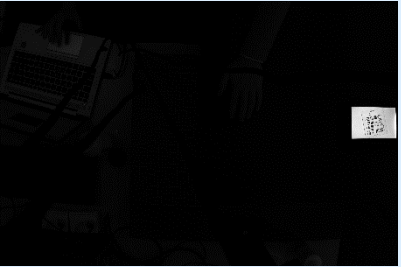

Image quality

- No vignetting up to 1.1" format
- Significant barrel distortion, which can be corrected digitally



Best resolution is achieved at F/5.6

- Several series of test images were acquired at different field positions & f-numbers
- The focus was set at about 50% off-center and kept constant
- For the table below a 1m working distance and a red back-light was used

1m WD	Center	Edge	Corner
USAF target position			
F/2.8	177	95	90
F/4	190	150	105
F/5.6	203	172	168

- Note: Re-focusing in corner area brings resolution up significantly
→ field curvature could be removed by image stacking

Specifications

Model		VS-FT12HV			
Focus tunable lens	Model	EL-16-40-TC			
	Optical power	-2 dpt	0 dpt	+0.5 dpt	+2.5 dpt
Focal Length (f)		12 mm			
Maximum Aperture Ratio		1 : 2.8			
Aperture		F 2.8 ~ F16			
WD		Over Infinity	1000 mm	490 mm	150 mm
Angle of View	(1.1")	-	47.8 X 66.6°	47.6 X 66.2°	46.4 X 64.5°
TV Distortion	(1.1")	-	-7.1 %	-7.0 %	-6.5 %
Relative illuminance	(Y=8.75)	-	64 %	64 %	64 %
Operation	(Iris)	Manual (Lock screw M2)			
Wavelength		Visible			
Mount		C-Mount			
Flange Back		17.526 mm			
Sensor Size (max.)		1.1"			
Filter Thread		M 40.5 P= 0.5			
Weight (approx.)		210 g			
Dimension		ϕ 47 (max.) × L = 64 mm			
Repeatability in focal power mode		±0.05dpt (small steps) ±0.1dpt (large steps)			
Response (typical at 30°C, 0 to +/- 250mA step)		5ms			
Setting time (typical at 30°C, 0 to +/- 250mA step)		25ms			
Lifecycles (10%-90% sinusoidal)		>1,000,000,000			

Mechanical design (with Hirose connector)

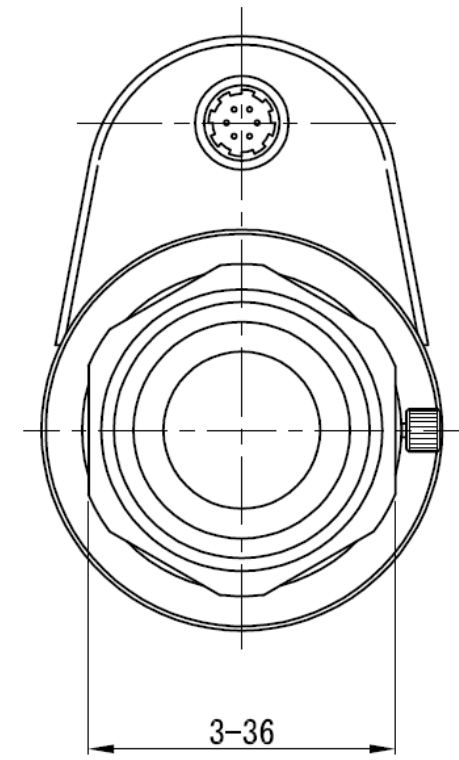
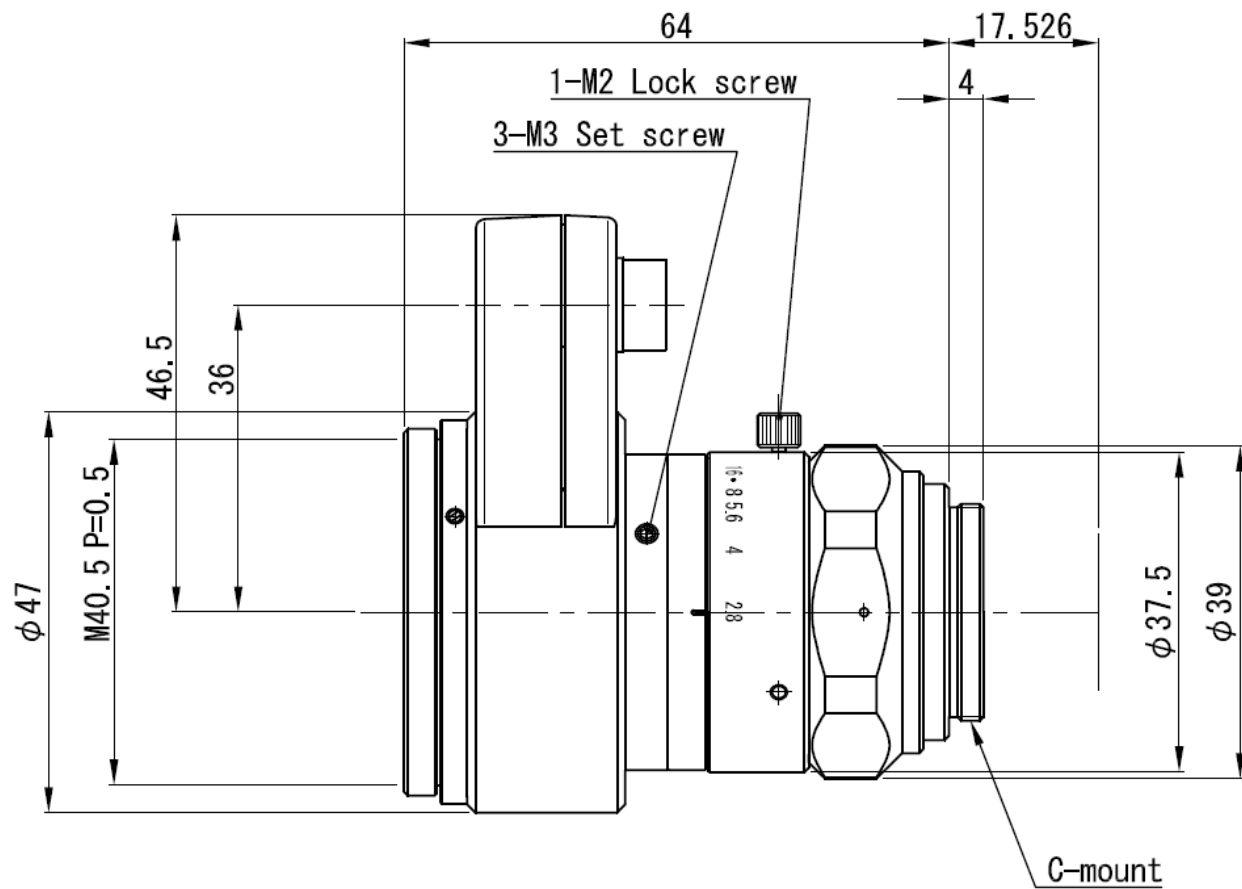

Mechanical design (with flex cable)

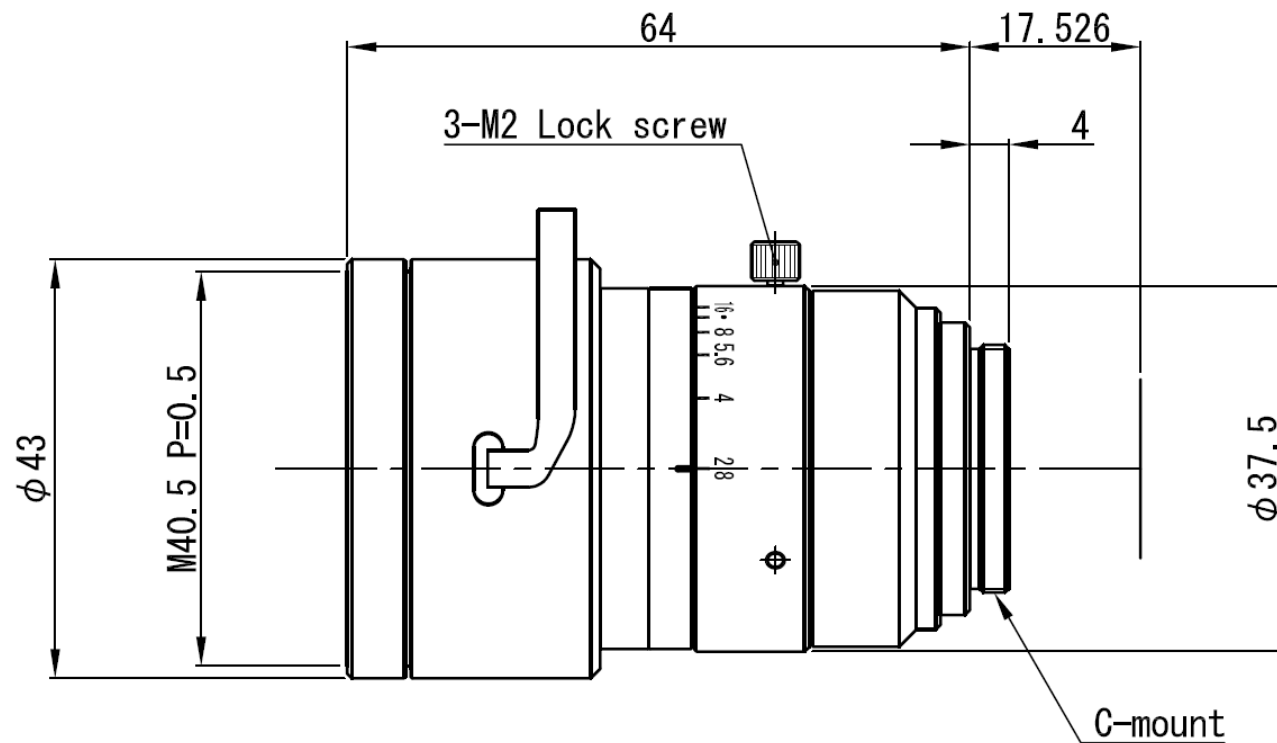

Test setup 1 with 1" sensor, 2.4um pixel size



Camera: Baumer VCXU-201M.R, 1" CMOS,
2.4 um pixel size, 5472×3648 pixels

Driver: Optotune lens driver 4i

Lens: VST VS-LQ12H11, 12 mm lens with
integrated liquid lens EL-16-40-TC-VIS

Target: USAF chrome target

Light: Red in background illumination

WD 970 mm, lens @ 0.54 dpt, F/5.6

Camera

Sensor size = 5472×3648 pixels

Nyquist limit = 208 lp/mm

Pixel size = 2.4 μ m

Center

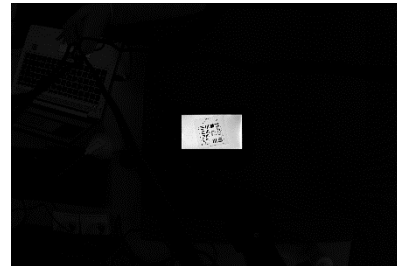

Edge

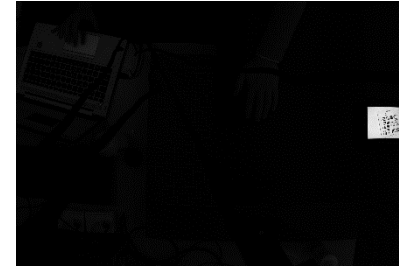

Corner

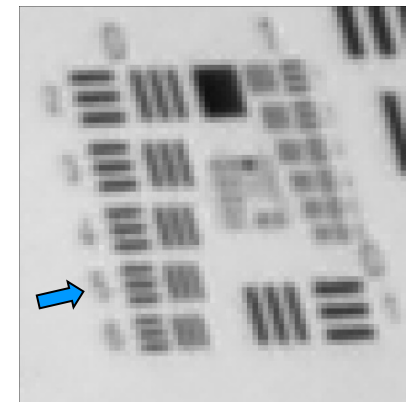
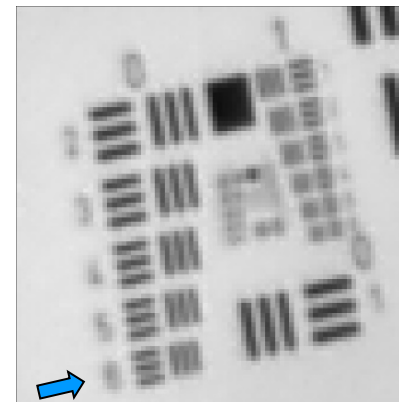
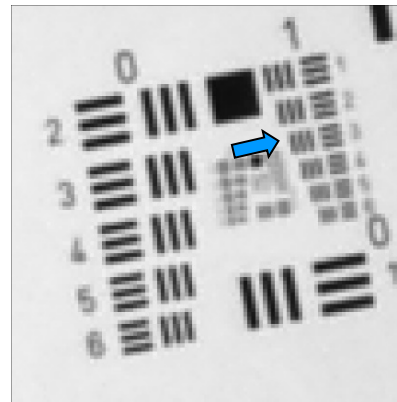
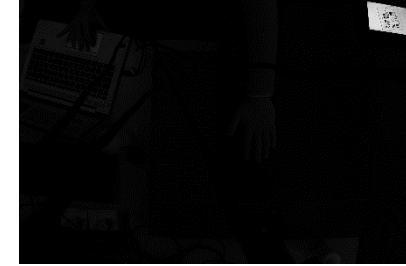

USAF element:	1/3	0/6	0/5
Line width (μ m):	198.43	280.62	314.98
Lp/mm (object):	3	2	2
Magnification:	0.012	0.010	0.009
Lp/mm (image):	203	172	168

WD 500 mm, lens @ 1.00, F/5.6

Camera

Sensor size = 5472×3648 pixels

Nyquist limit = 208 lp/mm

Pixel size = 2.4 μ m

Center

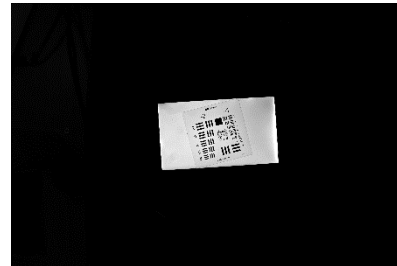

Edge

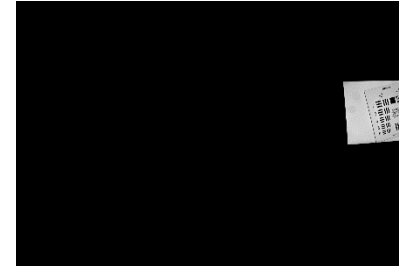

Corner

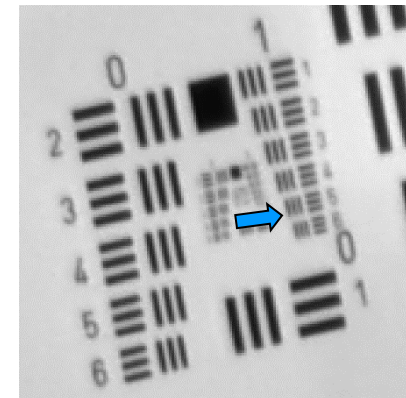
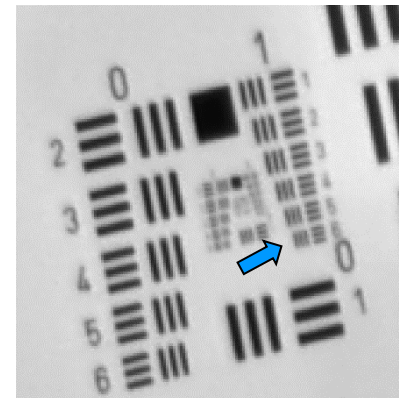
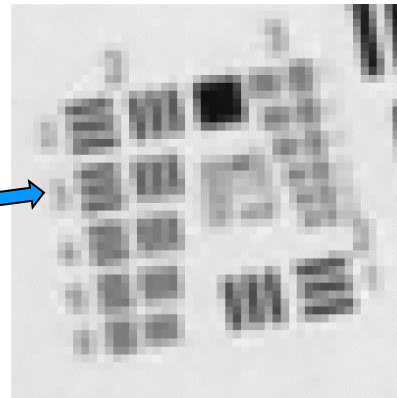
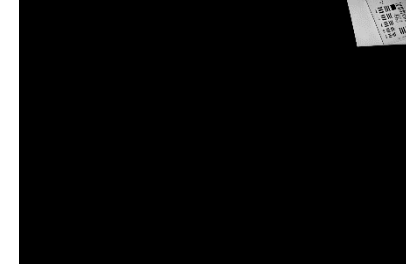

USAF element:	2/2	1/6	1/5
Line width (μ m):	111.36	140.31	157.49
Lp/mm (object):	4	4	3
Magnification:	0.025	0.020	0.019
Lp/mm (image):	181	174	170

WD 250 mm, lens @ 1.94 dpt, F/5.6

Camera

Sensor size = 5472×3648 pixels

Nyquist limit = 208 lp/mm

Pixel size = 2.4 μ m

Center

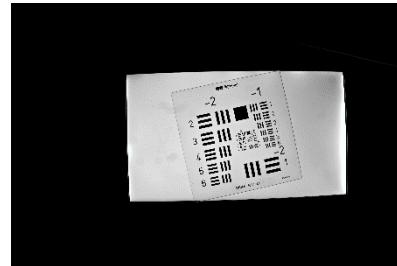

Edge

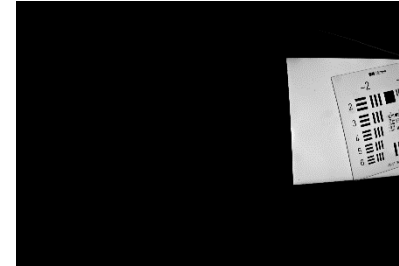

Corner

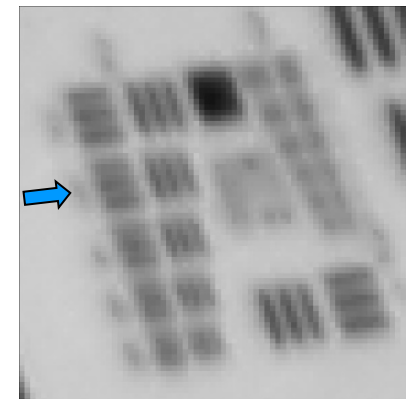
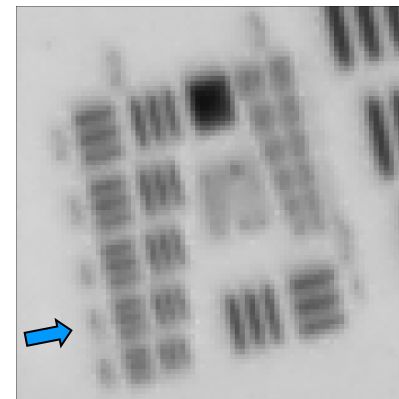
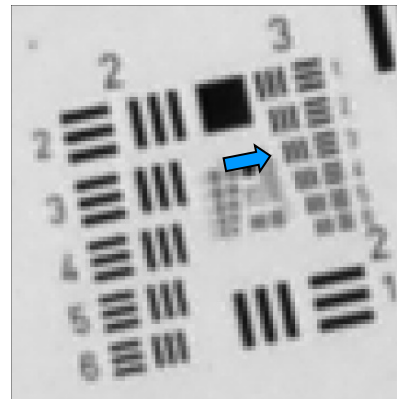
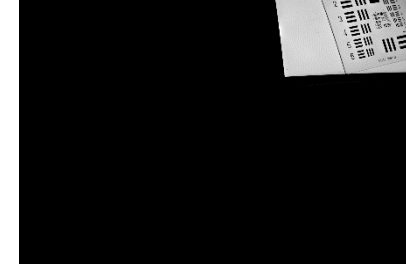

USAF element:	3/3	2/5	2/2
Line width (μ m):	49.61	78.75	111.36
Lp/mm (object):	10	6	4
Magnification:	0.048	0.039	0.038
Lp/mm (image):	208	164	117

Test setup 2 with 1.1" sensor, 3.45um pixel size

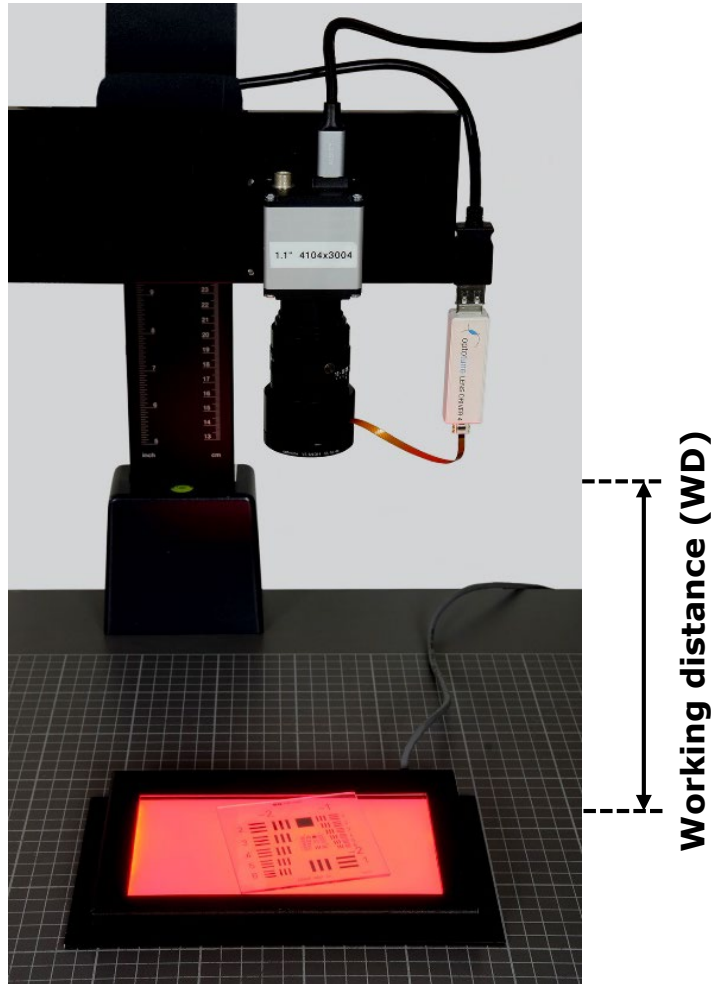

Camera: IDS UI-3200SE-M-GL, 1.1",
3.45um pixel size, 4104x3004 pixels

Driver: Optotune lens driver 4

Lens: VST VS-LQ12H11, 12 mm lens with
integrated liquid lens EL-16-40-TC-VIS

Target: USAF chrome target

Light: Red in background illumination

Note: Lens is available with ribbon cable or industrial Hirose connector

WD 970 mm, lens @ 0.52 dpt, F/4 Resolution at Nyquist limit

Camera

Sensor size = 4104x3004 pixels

Nyquist limit = 145 lp/mm

Pixel size = 3.45 μm

Center



Edge

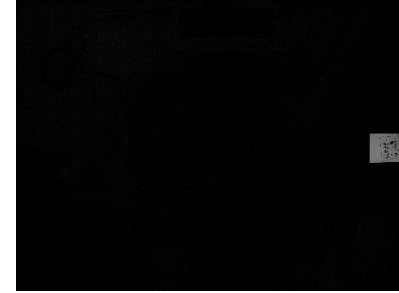

Corner

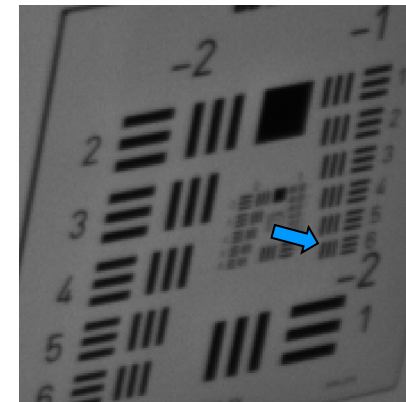
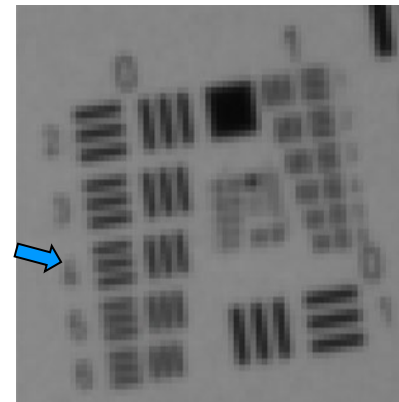
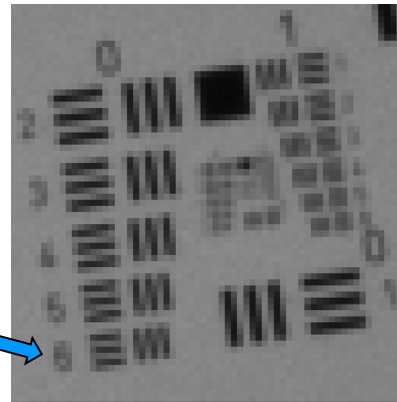
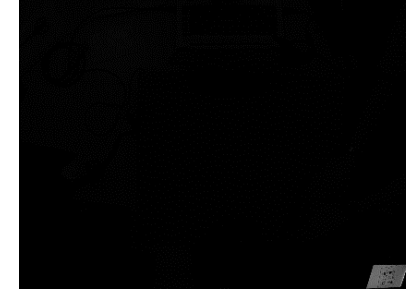

USAF element:	0/6	0/4	-1/6
Line width (μm):	280.62	353.55	561.23
Lp/mm (object):	2	1	1
Magnification:	0.013	0.010	0.009
Lp/mm (image):	139	140	105

WD 500 mm, lens @ 0.82 dpt, F/4 Resolution at Nyquist limit

Camera

Sensor size = 4104x3004 pixels

Nyquist limit = 145 lp/mm

Pixel size = 3.45 μ m

Center

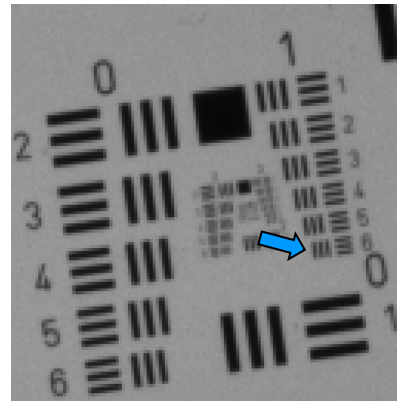
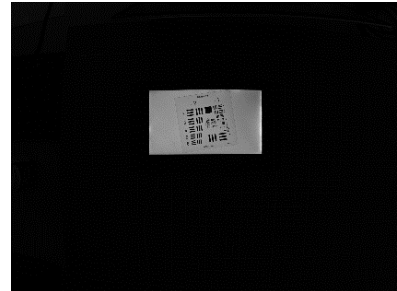

Edge

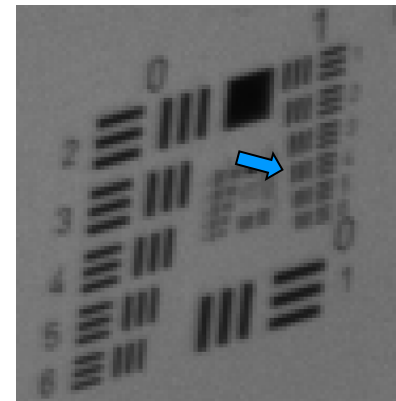

Corner

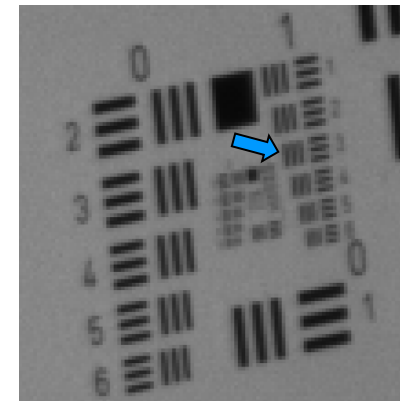

USAF element:	1/6	1/4	1/3
Line width (μ m):	140.31	176.78	198.43
Lp/mm (object):	4	3	3
Magnification:	0.026	0.021	0.019
Lp/mm (image):	137	137	133

WD 250 mm, lens @ 1.99 dpt, F/4 Resolution close to Nyquist limit

Camera

Sensor size = 4104x3004 pixels

Nyquist limit = 145 lp/mm

Pixel size = 3.45 μm

Center

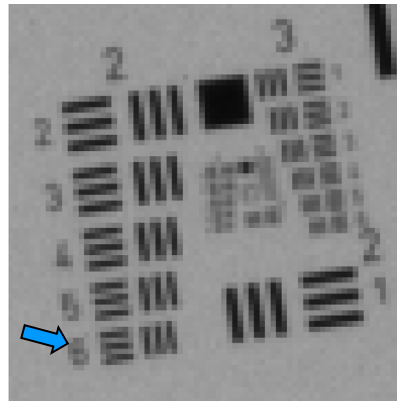
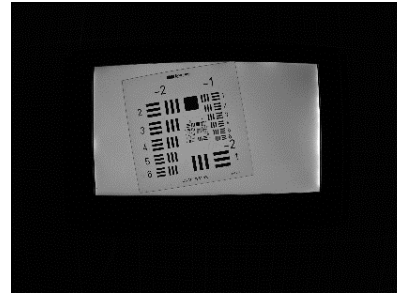

Edge

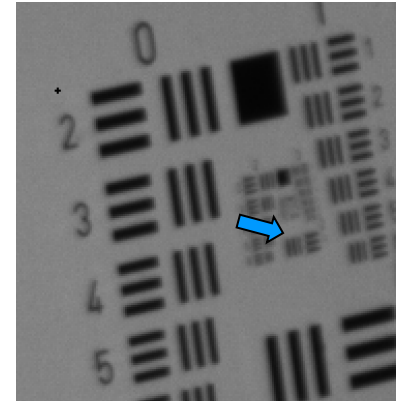
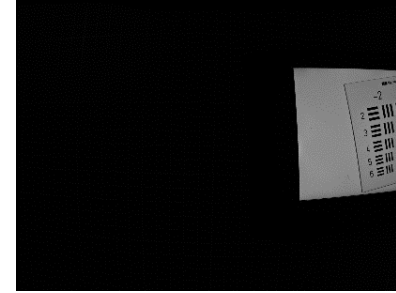

Corner

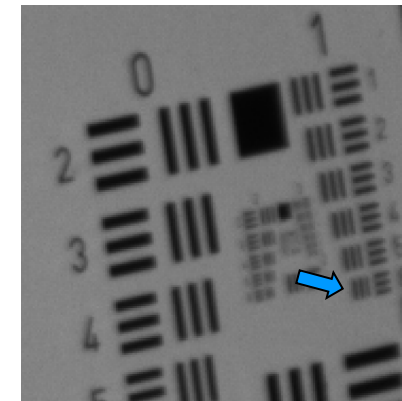
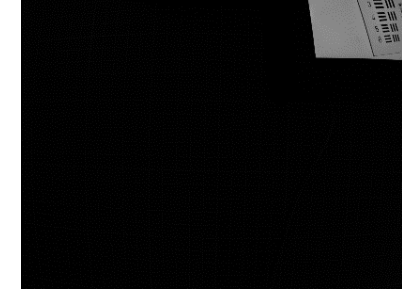

USAF element:	2/6	2/1	1/6
Line width (μm):	70.15	125	140.31
Lp/mm (object):	7	4	4
Magnification:	0.055	0.038	0.036
Lp/mm (image):	130	106	98

Barrel Distortion (WD 135 mm, 2.89 dpt)

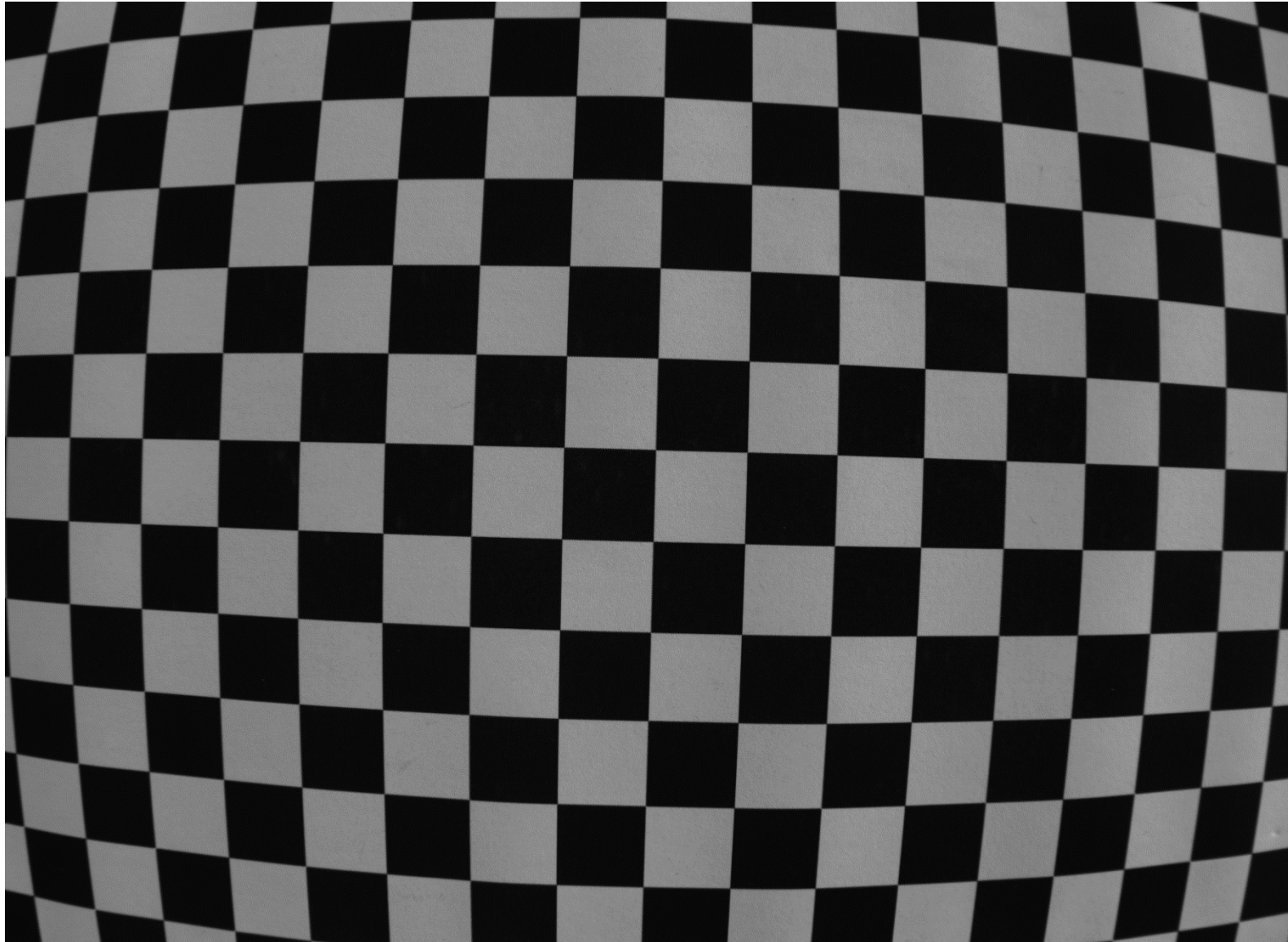

Barcodes at WD 500 mm

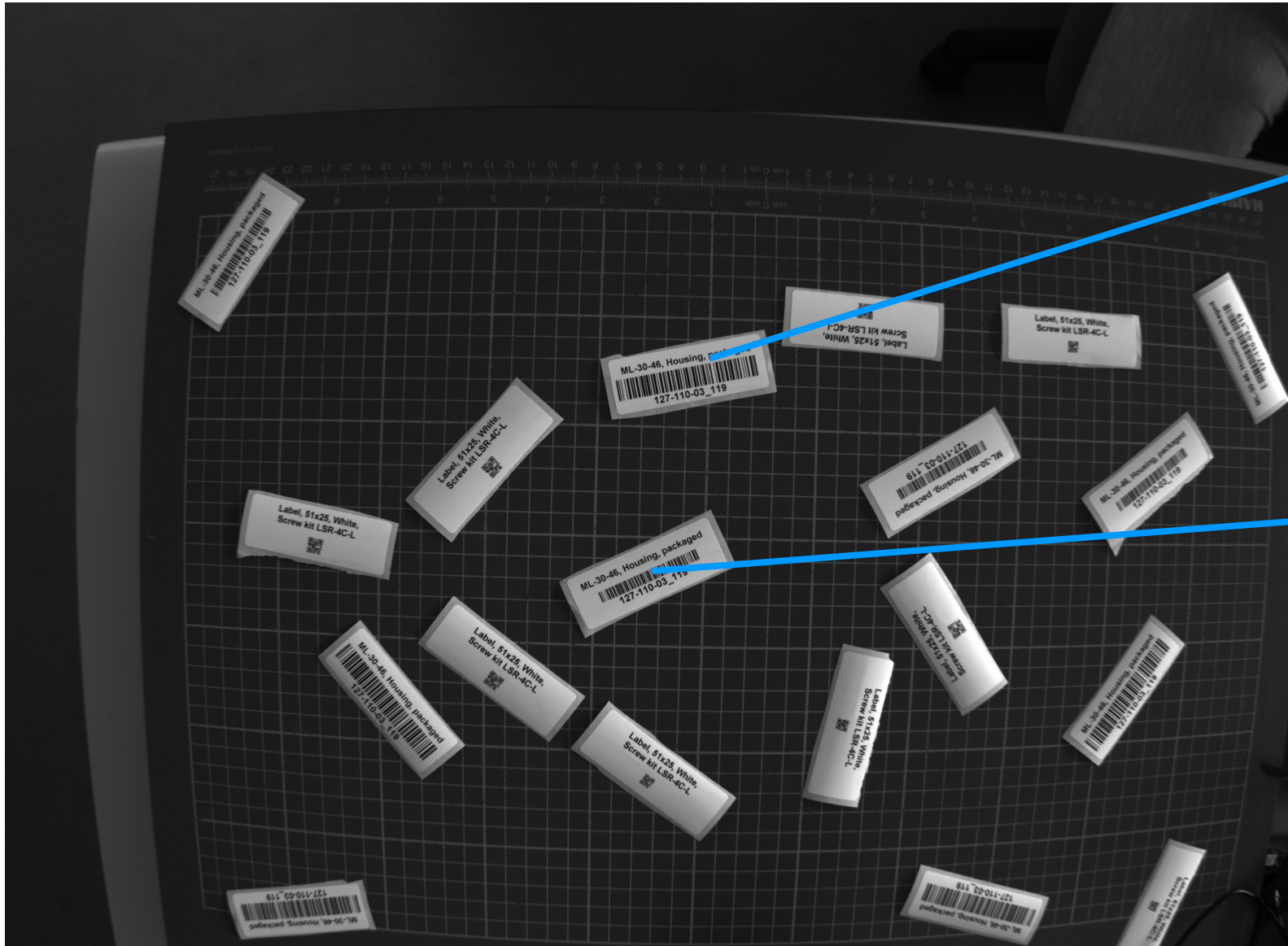

Printed at 13 mils

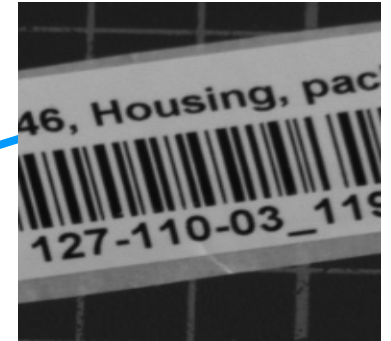

Printed at 10 mils



WD 940 mm has barcodes of 10 mils at pixel limit



Printed at 10 mils

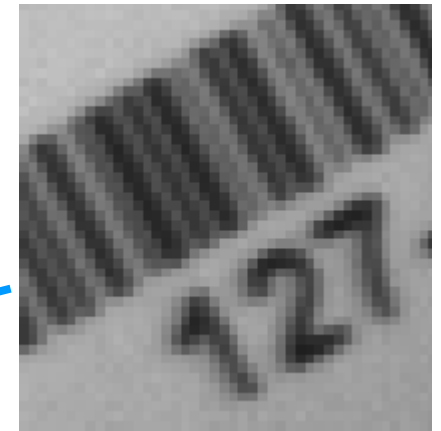

Printed at 13 mils

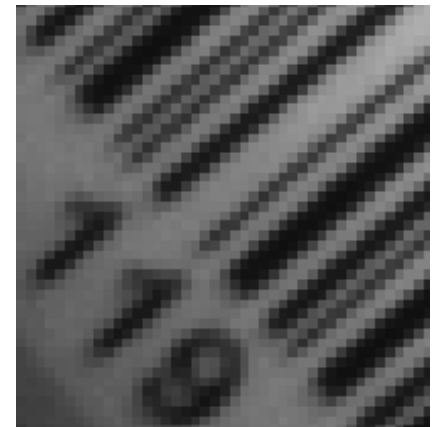

No vignetting visible (WD 120 mm, F/4)

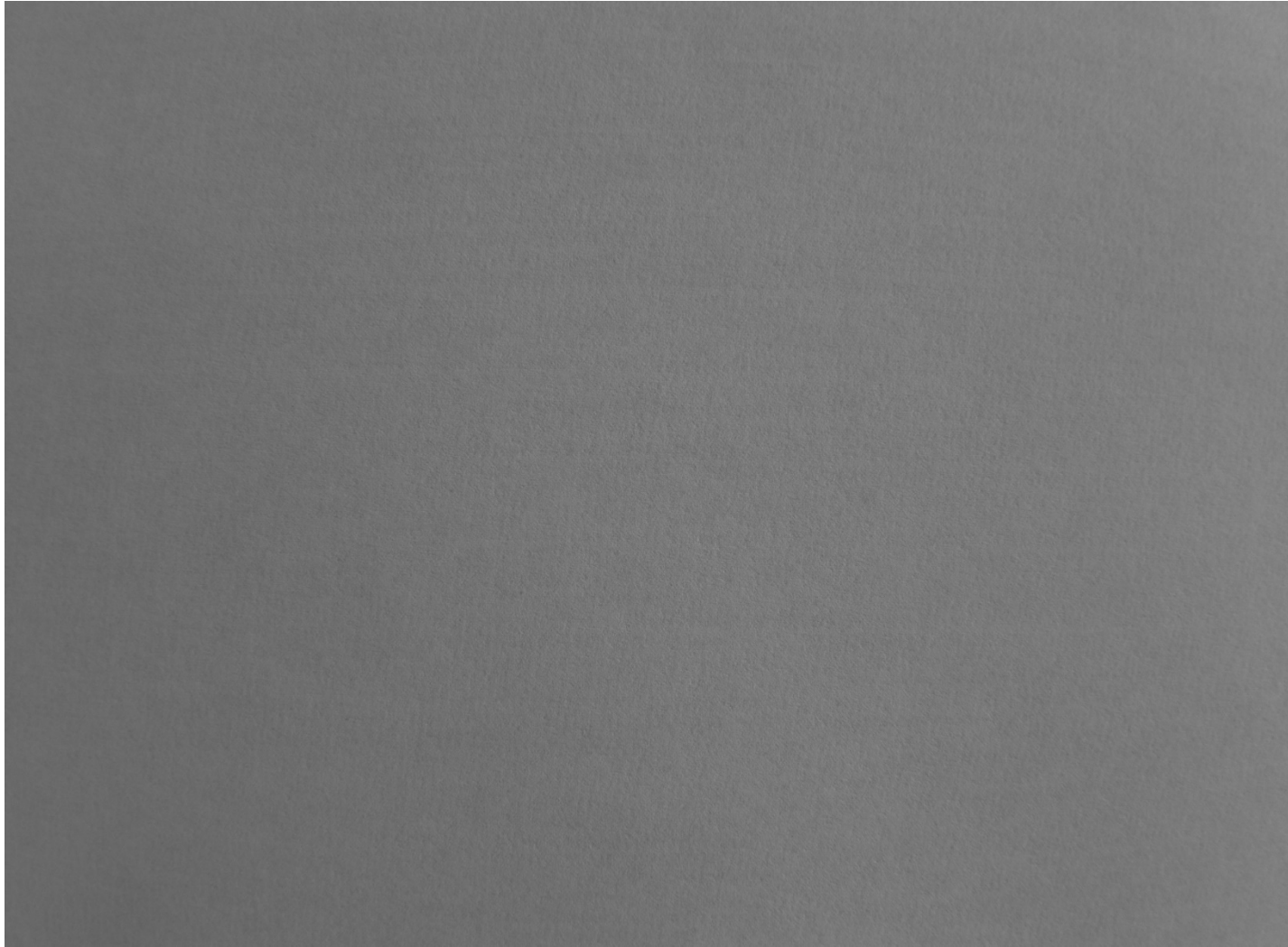

Optical leverage and FOV

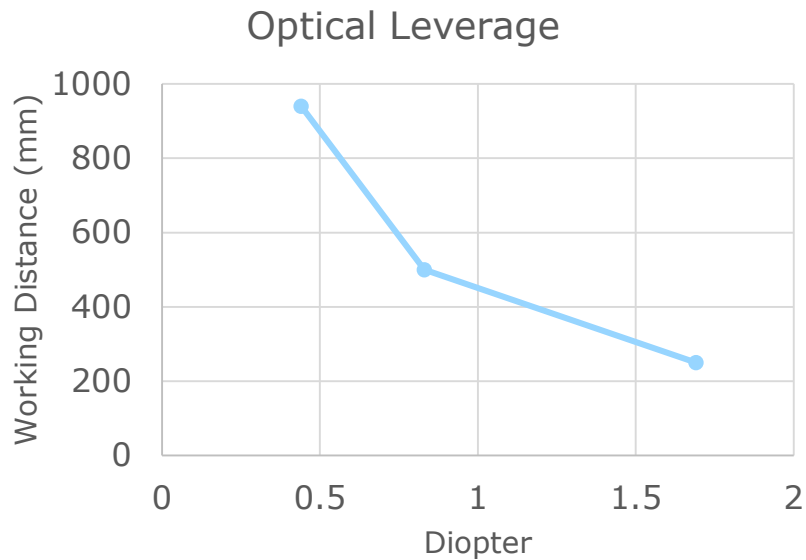

Optical leverage (WD change per diopter) of this lens is 1.13 m/dpt in the 0.5 to 1 m range.

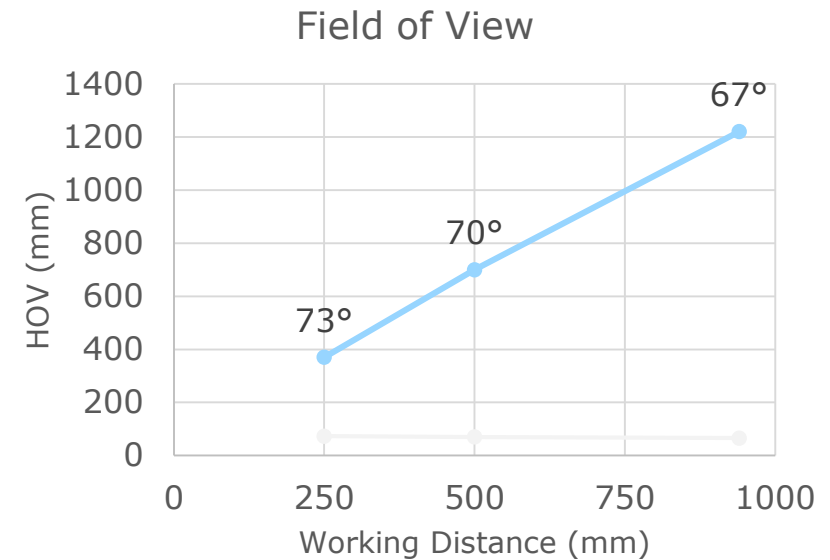

Beneficial "zoom effect":
Focusing at short WD actually increases the angular FOV slightly.

Field Curvature at 940 mm WD

Magnification changes from 0.013 to 0.009 from center to corner

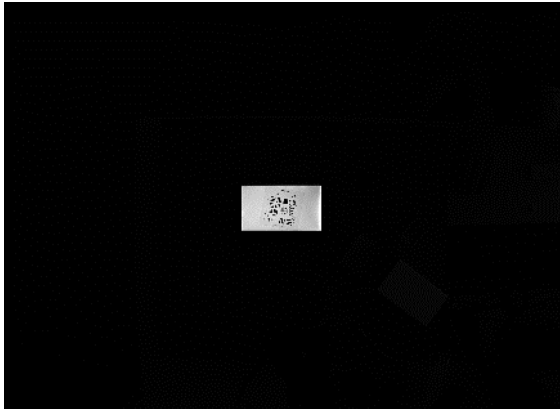

33 pixels = 2227 μm

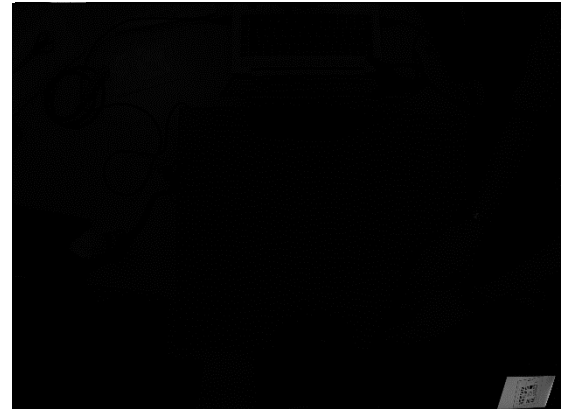
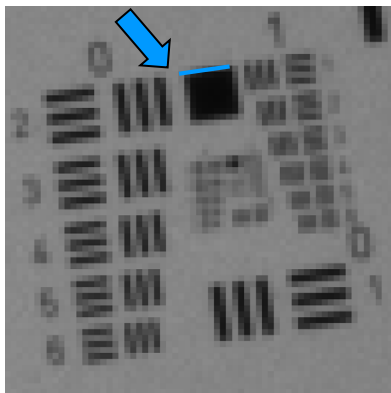

22 pixels = 8909 μm

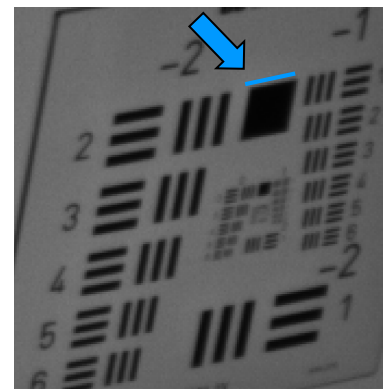

Distortion can be corrected digitally

Original image

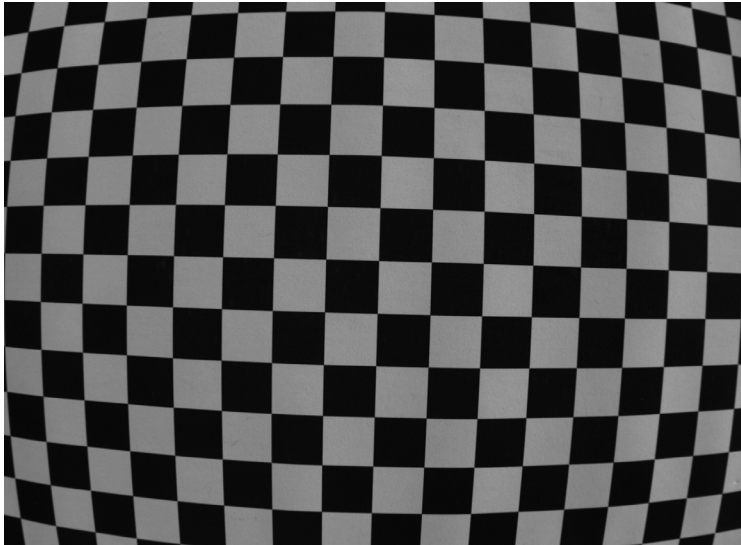

Standard barrel distortion correction in Photoshop

